



Acme Sanitary Ware Co Ltd

Acme Building, 22-28 Nanking Street, Kowloon, Hong Kong
Tel: 2388 7171 Fax: 2710 8012
E-mail: acme@acmesanitary.com.hk
Website: www.acmesanitaryware.com.hk



PROJECT		REF		REV	ITEM CODE	
LOCATION		DATE			PAGE	

SANITARY WARE SPECIFICATION SHEET

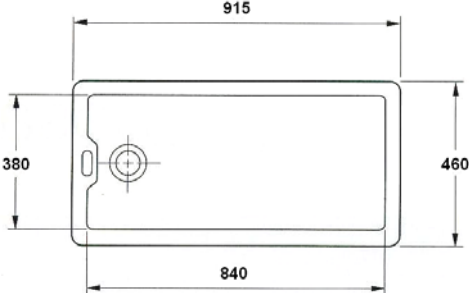
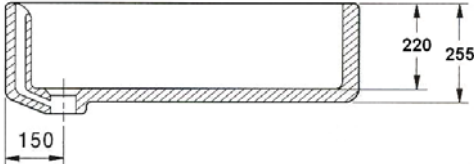
Item Descriptions	Shires (UK) 'Belfast' fireclay sink	Illustration/ Drawing
Dimensions	915 x 460 x 255 mm	  
Model	BFF9102WH	
Material/Colour	Fireclay / White	
Manufacturer	Shires (UK)	
Source	Acme Sanitary Ware Co. Ltd Mr. Eric Wong/ Mr. Wilson Hung	
Contact Tel/Fax	(852) 2388-7171 / (852) 2710-8012	
E-mail	acme@acmesanitary.com.hk	
Website	www.acmesanitary.com.hk	

Note:

* All information of the above is the reference only. No prior notice is made if any changes.